

REVISION HISTORY				
ZONE	REV	DESCRIPTION	DATA	APPR

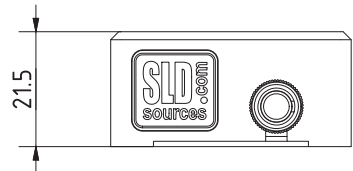

21.5

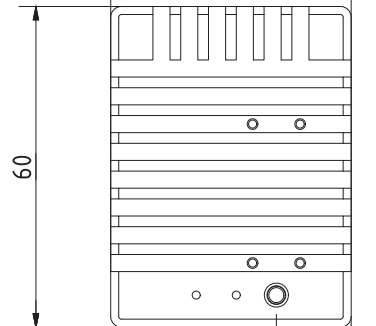

45
60

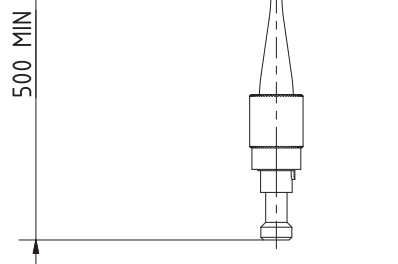

14
500 MIN

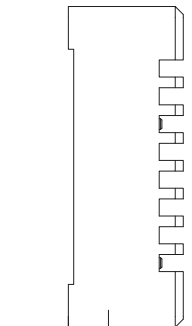

7.5

4 HOLES M2-6H ∇5

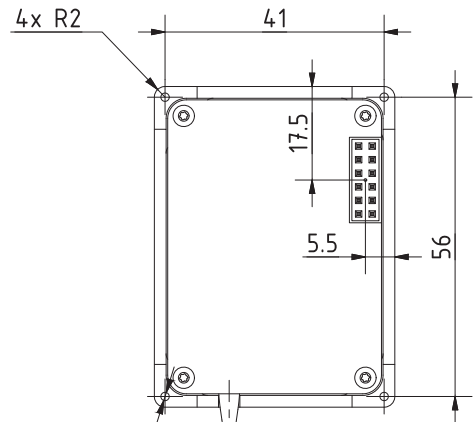

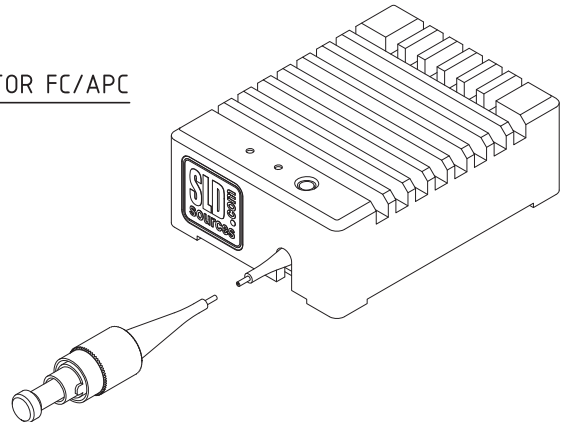

4x R2
41
17.5
5.5
56

OPTICAL CONNECTOR FC/APC



NOTES:
1. DIMENSIONS ARE IN MILLIMETERS (mm).
2. WEIGHT - 100 g.

	NAME	DATE	MATERIAL	TITLE	
DRN		27.04.2024		BROADBAND LIGHT SOURCE OF THE BS SERIES	
CHD				IDENTIFICATION NUMBER	
APPD			UNSPECIFIED TOLERANCES	3328.10.BS	
SCALE:	WEIGHT		±0.1	DOCUMENT TYPE	
1 : 1				DIMENSIONAL DRAWING	
REV	SHEET	SHEETS	FINISH		
A	1	1			